



Project _____

Item # _____

Quantity _____

180° Electric Waffle Makers

Models: KWM18-1BR35, -1BR46, -MBR43515, -1LG47
KWM18-1BU
KWM18-2LG47, -2BR46
KWM18-1RO7

Hatco®/Krampouz® KWM18 180° Waffle Makers produce excellent-quality waffles for commercial kitchens and display cooking locations. The adjustable temperature control enables operators to prepare waffles of consistent quality from a variety of different batters or doughs. Exclusive, removable top and bottom heating element packs provide exceptional heat distribution over the entire waffle plate surface. The Makers' Waffle Easy Clean System® provides quick removal and easy cleaning of the waffle plates.

Standard features

- KWM18 models are designed with 180° hinged waffle plates for cooking waffles from batter or dough
- Available with Liège or Brussels (rectangle or round) cast iron waffle plates
- Stainless steel frame, with a cast iron griddle, is designed for quality and durability
- Innovative Easy Clean System® allows for instant removal of the waffle plates, providing ease of maintenance and increased reliability
- Adjustable Thermostatic Control(s) with a range from 120°F – 570°F (50°C – 300°C) allows for precise temperature control
- Also comes with a power indicator, a heating indicator, a removable drip tray and a 6' (1829 mm) cord and plug



Accessories

- Waffle Pick - Metal Forks with Plastic Handle



 For operation, location and safety information, please refer to the Installation and Operating Manual.

HATCO CORPORATION | P.O. Box 340500 Milwaukee, WI 53234-0500 U.S.A. | (414) 671-6350



www.hatcocorp.com | support@hatcocorp.com | [Find a Hatco Rep](#) | [Image Library](#) | [Document Library](#) | [Patents](#) | [Chat](#)



Waffle Makers

Models: KWM18-1BR35, -1BR46, MBR43515, -1LG47 KWM18-1BU
KWM18-2LG47, -2BR46 KWM18-1RO7

KWM18-1 SERIES

180° HINGE, SINGLE HEAD WAFFLE MAKERS

These models have 180° hinged waffle plates and are designed for cooking waffles from batter/dough.

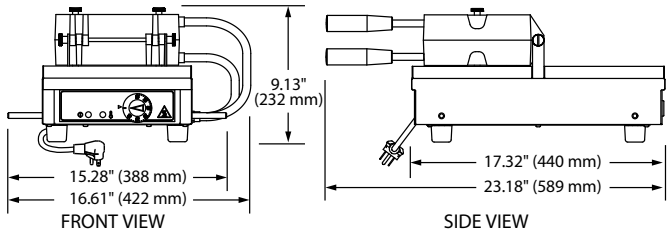

SPECIFICATIONS

180° Hinge, Single Head Waffle Makers

Model	Item No.	Description	Dimensions (W x D x H)	Voltage	Watts	Amps	Plug	Ship Weight*
KWM18-1BR35	KWM18.1BR35515	180°, single, 3" x 5" Brussel	16.61" x 23.18" x 9.13" (422 x 589 x 232 mm)	120	1440	12.0	NEMA 5-15P	46 lbs. (21 kg)
KWM18-1BR46	KWM18.1BR46515	180°, single, 4" x 6" Brussel	16.61" x 23.18" x 9.13" (422 x 589 x 232 mm)	120	1440	12.0	NEMA 5-15P	49 lbs. (22 kg)
	208-240 [©]			1352-1800	6.5-7.5	NEMA 6-20P		
KWM18-1LG47	KWM18.1LG47 515	180°, single, 4" x 7" Liege	16.61" x 23.18" x 9.13" (422 x 589 x 232 mm)	120	1440	12.0	NEMA 5-15P	45 lbs. (20 kg)
	208-240 [©]			1352-1800	6.5-7.5	NEMA 6-20P	45 lbs. (20 kg)	

* Shipping weight includes packaging.

© Unit is designed to operate on supply voltages between 208V and 240V.

CORD LOCATION

Bottom center of unit.

KWM18-MBR43515 180° HINGE, SINGLE HEAD MINI BRUSSELS WAFFLE MAKER

These models have 180° hinged mini brussels plates and are designed for cooking waffles from batter.

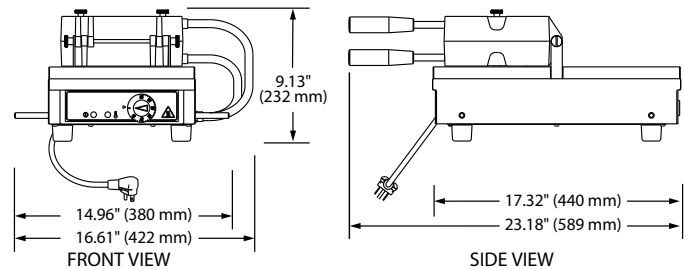

SPECIFICATIONS

180° Hinge, Single Head Mini Brussels Waffle Maker

Model	Item No.	Description	Dimensions (W x D x H)	Voltage	Watts	Amps	Plug	Ship Weight*
KWM18-MBR43515	KWM18.MBR43515	180°, single, square	23.18" x 16.61" x 9.13" (589 x 422 x 232 mm)	120	1440	12.0	NEMA 5-15P	53 lbs. (24 kg)

* Shipping weight includes packaging.

CORD LOCATION

Bottom left side of unit.

KWM18-1 SERIES

180° HINGE, SINGLE HEAD BUBBLE WAFFLE MAKER

This model has 180° hinged waffle plates and is designed for cooking waffles from batter/dough.

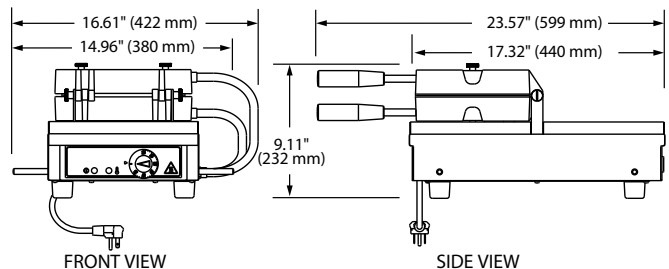

SPECIFICATIONS

180° Hinge, Single Head Bubble Waffle Maker

Model	Item No.	Description	Dimensions (W x D x H)	Voltage	Watts	Amps	Plug	Ship Weight*
KWM18-1BU	KWM18.1BU515	180°, single, Bubble	16.61" x 23.57" x 9.11" (422 x 599 x 232 mm)	120	1440	12.0	NEMA 5-15P	53 lbs. (24 kg)

* Shipping weight includes packaging.

CORD LOCATION

Bottom center of unit.

HATCO CORPORATION | P.O. Box 340500 Milwaukee, WI 53234-0500 U.S.A. | (414) 671-6350



www.hatcocorp.com | support@hatcocorp.com | [Find a Hatco Rep](#) | [Image Library](#) | [Document Library](#) | [Patents](#) | [Chat](#)



Waffle Makers

Models: KWM18-1BR35, -1BR46, MBR43515, -1LG47 KWM18-1BU
KWM18-2LG47, -2BR46 KWM18-1RO7

KWM18-2 SERIES 180° HINGE, DUAL HEAD WAFFLE MAKERS

These models have 180° hinged waffle plates and is designed for cooking waffles from batter/dough.

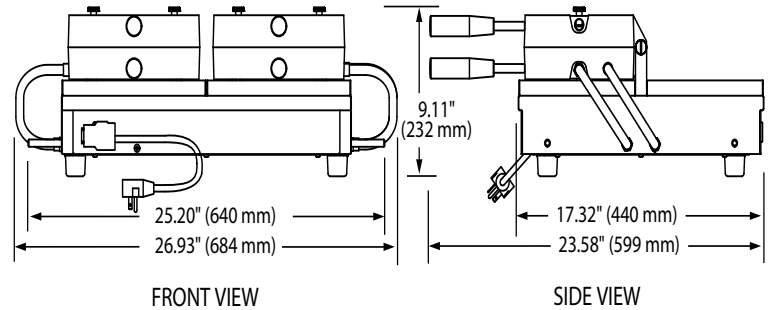

SPECIFICATIONS 180° Hinge, Dual Head Waffle Makers

Model	Item No.	Description	Dimensions (W x D x H)	Voltage	Watts	Amps	Plug	Ship Weight*
KWM18-2LG47	KWM18.2LG47620	180°, double, 4" x 7" Liege	26.93" x 23.58" x 9.11" (684 x 599 x 232 mm)	208-240 [©]	2704-3600	13.0-15.0	NEMA 6-20P	72 lbs. (33 kg)
KWM18-2BR46	KWM18.2BR46620	180°, double, 4" x 6" Brussels	26.93" x 23.58" x 9.11" (684 x 599 x 232 mm)	208-240 [©]	2704-3600	13.0-15.0	NEMA 6-20P	72 lbs. (33 kg)

* Shipping weight includes packaging.
[©] Unit is designed to operate on supply voltages between 208V and 240V.

CORD LOCATION Bottom center of unit.

KWM18-1 ROUND SERIES 180° HINGE, SINGLE HEAD ROUND WAFFLE MAKER

This model has 180° hinged waffle plates and is designed for cooking waffles from batter/dough.

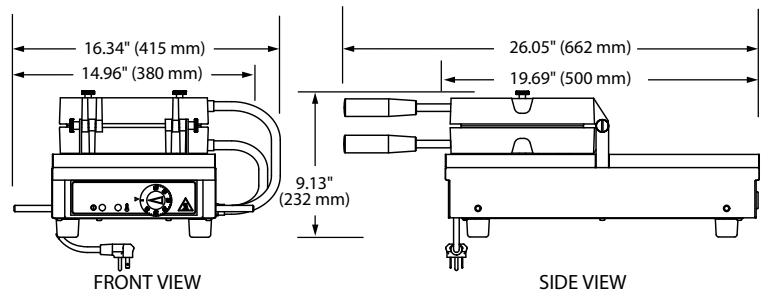

SPECIFICATIONS 180° Hinge, Single Head Round Waffle Maker

Model	Item No.	Description	Dimensions (W x D x H)	Voltage	Watts	Amps	Plug	Ship Weight*
KWM18-1RO7	KWM18.1RO7515	180°, single, Round	16.34" x 26.05" x 9.13" (415 x 662 x 232 mm)	120	1440	12.0	NEMA 5-15P	57 lbs. (26 kg)

* Shipping weight includes packaging.

CORD LOCATION Facing controls, bottom left side of unit.

PLUG CONFIGURATIONS

NEMA 5-15P

NEMA 6-20P

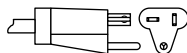
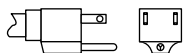

PRODUCT SPECS Waffle Makers

The Waffle Makers shall be Model ... as distributed by the Hatco Corporation, Milwaukee, WI 53234 U.S.A.

The Waffle Maker shall be rated at ... watts, ... volts, and be ... inches (millimeters) in overall width.

It shall consist of stainless steel frame and cast iron waffle plates. Waffle Makers feature removable cast iron waffle plates for either Brussels (Belgian), Mini Brussels

(Belgian) or Liège-style bubble waffles. The Waffle Makers' Easy Clean System provides quick removal and easy cleaning of the waffle plates. Also, an adjustable Temperature Control(s), a power indicator and a removable drip tray. All units are equipped with a factory attached 6' (1829 mm) power cord and plug.

Accessories shall include a waffle pick.

Warranty consists of 24/7 parts and service assistance (US and Canada only).

HATCO CORPORATION | P.O. Box 340500 Milwaukee, WI 53234-0500 U.S.A. | (414) 671-6350



www.hatcocorp.com | support@hatcocorp.com | [Find a Hatco Rep](#) | [Image Library](#) | [Document Library](#) | [Patents](#) | [Chat](#)